

SECTION 1200

LANDSCAPE

STANDARD

THIS PAGE INTENTIONALLY LEFT BLANK



ROAD AND BRIDGE STANDARDS

SHEET 1 OF 1

REVISION DATE

TITLE

VIRGINIA DEPARTMENT OF TRANSPORTATION

SPECIFICATION
REFERENCE

STANDARD	TITLE	PAGE
L-3	BENCH PLANTING ON ROCK CUT SECTION	1201.01
L-3A	HORIZONTAL GROOVING CUT SLOPES	1201.02
L-4	METHOD OF PLANTING FOREST TREE SEEDLINGS	1201.03
L-5	PLANTING DETAILS	1201.04
	PLANTING DETAILS	1201.05
	PLANTING DETAILS (ON SLOPES)	1201.06
L-6	FERTILIZER AND MULCH	1201.07
TW-1	STANDARD TREE WALLS AND TREE WELLS	1201.08
PT-1	PRECAST CONCRETE PICNIC TABLE	1201.09
RW-1	DRY RUBBLE RETAINING WALL	1201.10
RW-1A	MORTAR RUBBLE RETAINING WALL (LEVEL BACKFILL)	1201.11
RW-1B	MORTAR RETAINING WALL (INFINITE SURCHARGE AND DECK SURCHAARGE - LOADED)	1201.12

**INDEX OF SHEETS
SECTION 1200-LANDSCAPE**

VIRGINIA DEPARTMENT OF TRANSPORTATION



ROAD AND BRIDGE STANDARDS

REVISION DATE

SHEET 1 OF 1

1200.01

THIS PAGE INTENTIONALLY LEFT BLANK



ROAD AND BRIDGE STANDARDS

SHEET 1 OF 1

REVISION DATE

1200.02

SPECIFICATION
REFERENCE

VIRGINIA DEPARTMENT OF TRANSPORTATION

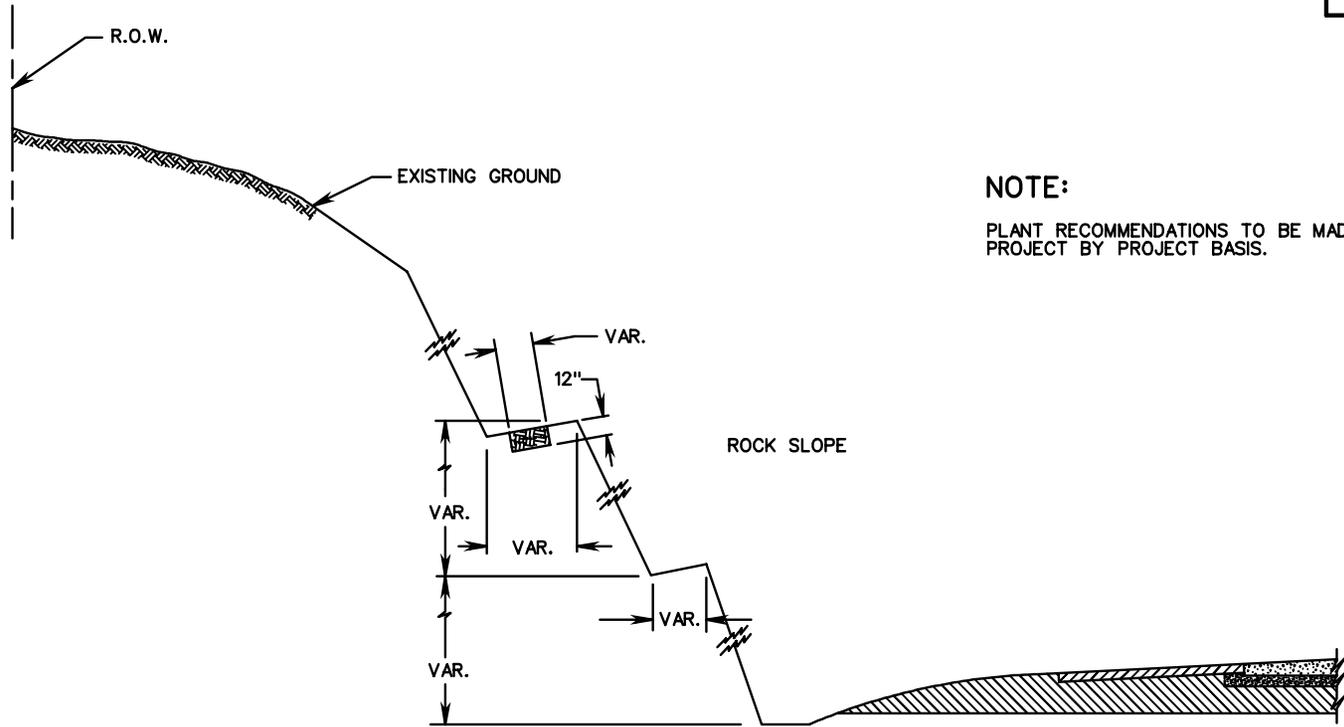

NOTE:

PLANT RECOMMENDATIONS TO BE MADE ON A PROJECT BY PROJECT BASIS.

SECTION A-A

THIS SECTION IS TO BE USED AS A GUIDE ONLY.
EACH ROCK CUT SHOULD RECEIVE INDIVIDUAL INVESTIGATION.

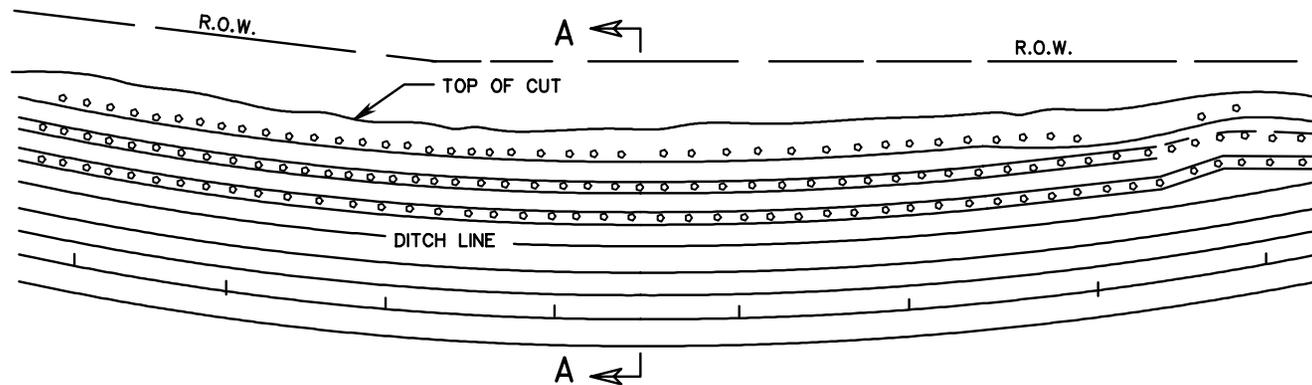

SPECIFICATION REFERENCE
NONE

BENCH PLANTING ON ROCK CUT SECTION
TYPICAL SECTION
VIRGINIA DEPARTMENT OF TRANSPORTATION

VDOT ROAD AND BRIDGE STANDARDS	
REVISION DATE	SHEET 1 OF 1
1201.01	

L-3A

CUT SLOPES STEEPER THAN 2:1 SHALL BE GROOVED IN ACCORDANCE WITH DETAILS SHOWN.

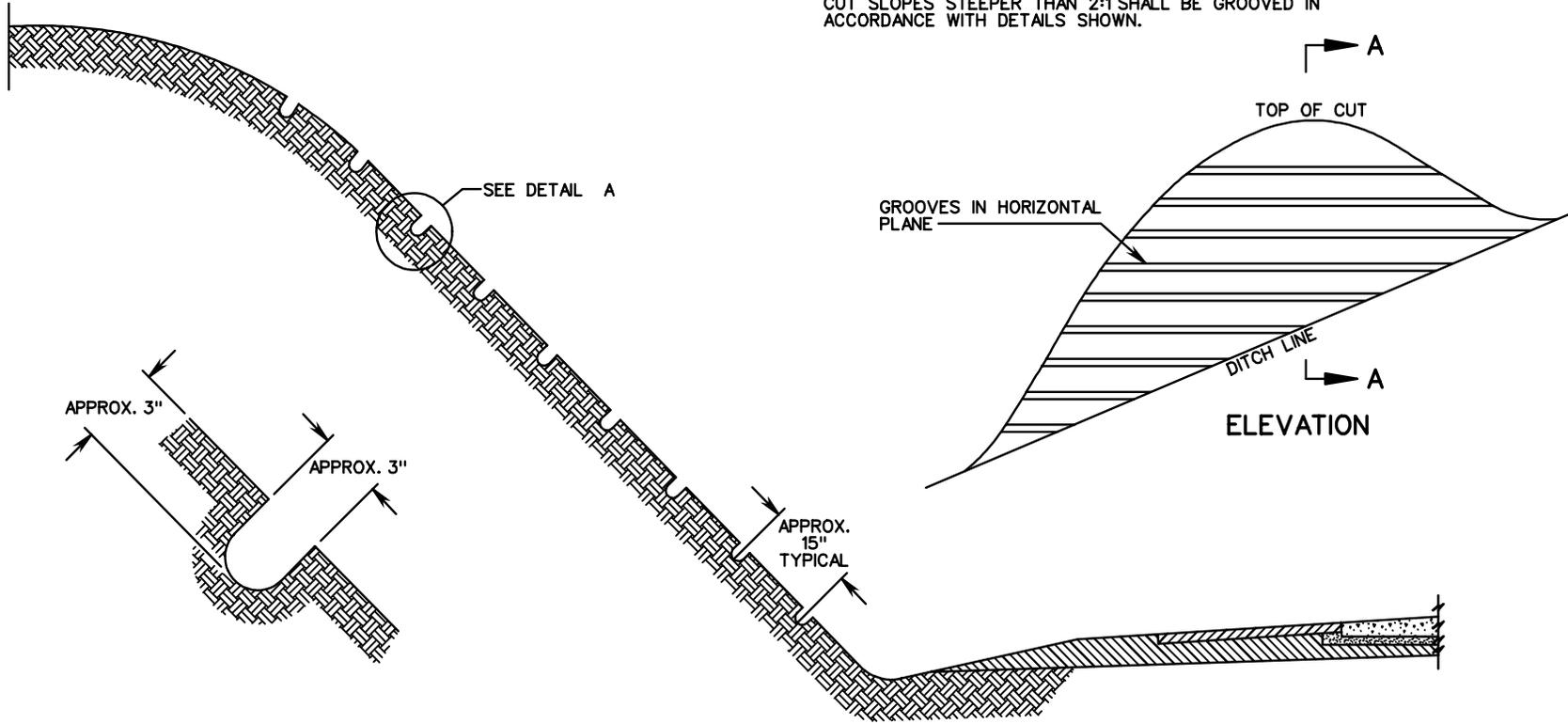

DETAIL A

SECTION A-A



ROAD AND BRIDGE STANDARDS

HORIZONTAL GROOVING CUT SLOPES
TYPICAL METHOD

SPECIFICATION
REFERENCE

SHEET 1 OF 1

REVISION DATE

VIRGINIA DEPARTMENT OF TRANSPORTATION

303

1201.02

PLANTING WITH BAR

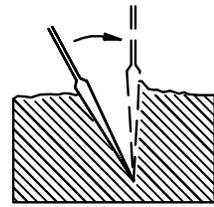

1. INSERT BAR AT ANGLE SHOWN. PUSH FORWARD TO UPRIGHT POSITION.

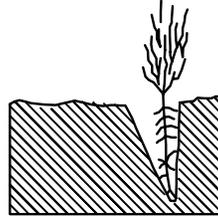

2. REMOVE BAR. PLACE SEEDLING AT CORRECT DEPTH.

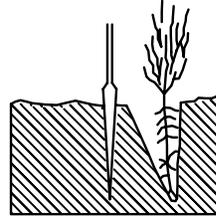

3. INSERT BAR 2 INCHES TOWARD PLANTER FROM SEEDLING.

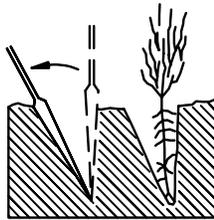

4. PULL HANDLE OF BAR TOWARD PLANTER FIRING SOIL AT BOTTOM OF ROOTS.

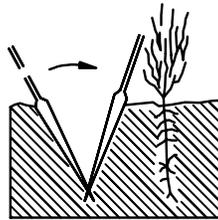

5. PUSH HANDLE OF BAR FORWARD FROM PLANTER FIRING SOIL AT TOP OF ROOTS.

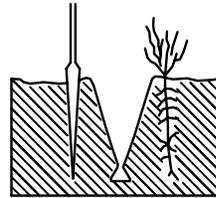

6. INSERT BAR 2 INCHES FROM LAST HOLE.

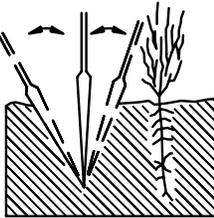

7. PUSH FORWARD THEN PULL BACKWARD FILLING HOLE.

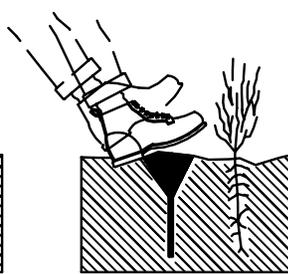

8. FILL IN LAST HOLE BY STAMPING WITH THE FEET.

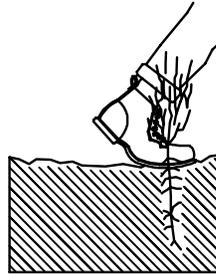

9. FIRM SOIL AROUND SEEDLING WITH THE FEET.

PLANTING WITH MATTOCK

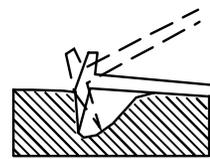

1. INSERT MATTOCK. LIFT HANDLE AND PULL.

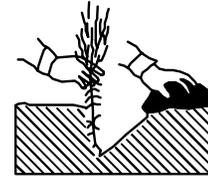

2. PLACE SEEDLING ALONG STRAIGHT SIDE AT CORRECT DEPTH.

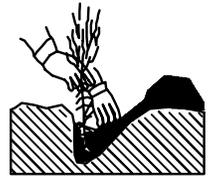

3. FILL IN AND PACK SOIL TO BOTTOM OF ROOTS.



4. FINISH FILLING IN SOIL. FIRM WITH HEEL.

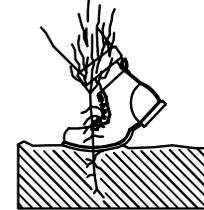

5. FIRM AROUND SEEDLING WITH FEET.

CORRECT AND INCORRECT DEPTHS

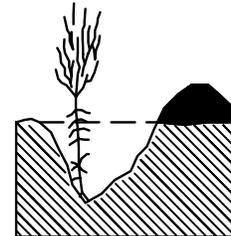

CORRECT

AT SAME DEPTH OR 1/2" DEEPER THAN IT GREW IN NURSERY.

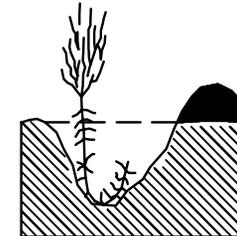

INCORRECT

TOO DEEP. ROOTS BENT.

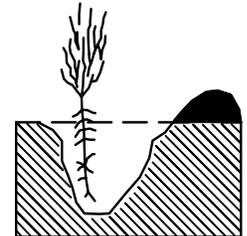

INCORRECT

TOO SHALLOW. ROOTS EXPOSED.

CORRECT

WET MOSS OR THICK MUDDY WATER.

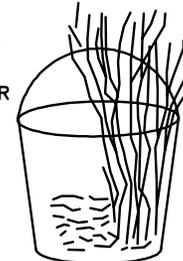

HANDLING

SEEDLING

IN

FIELD.

INCORRECT

ROOTS DRY OUT IN HAND.

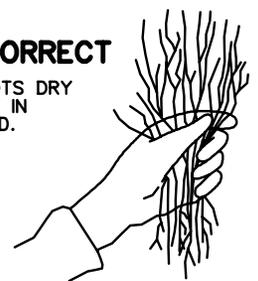

SPECIFICATION REFERENCE

605

METHOD OF PLANTING FOREST TREE SEEDLINGS

VIRGINIA DEPARTMENT OF TRANSPORTATION

VDOT

ROAD AND BRIDGE STANDARDS

REVISION DATE

SHEET 1 OF 1

1201.03

L-5

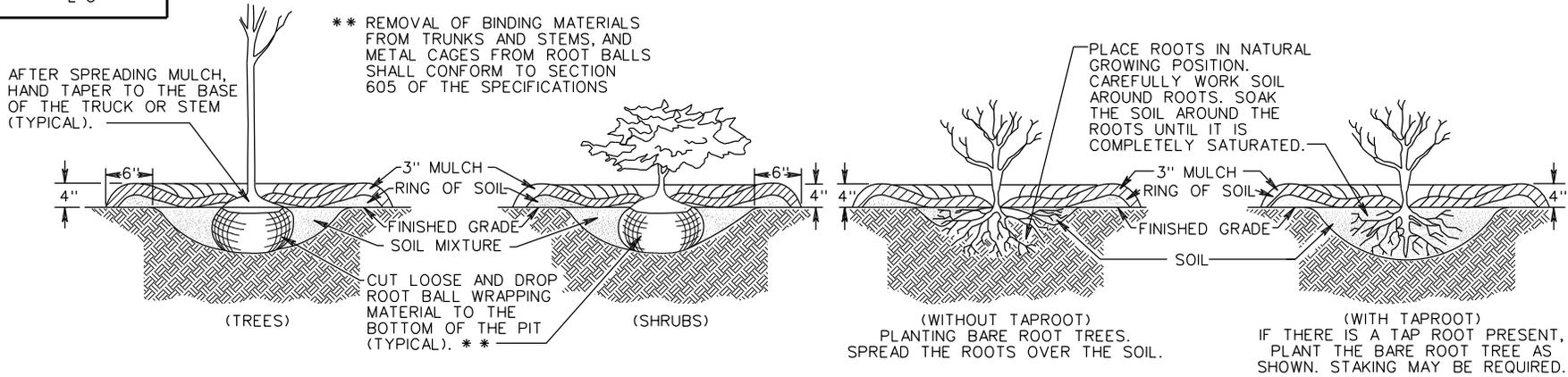

1 BALLED & BURLAPPED, & CONTAINER PLANTS

L-5

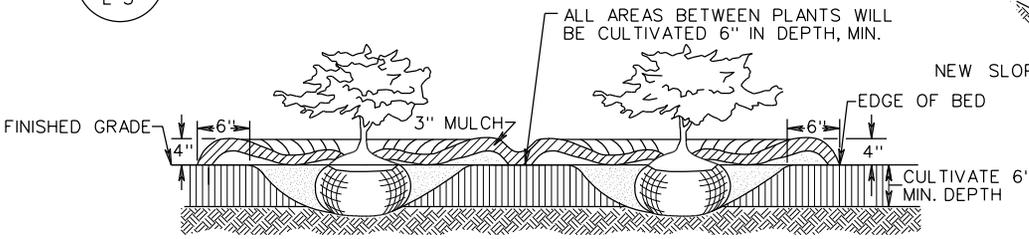

3 BED PLANTING

L-5

- WHEN A PORTION OF A PLANT BED EXTENDS INTO AN AREA STEEPER THAN 4:1, CULTIVATION OF THAT PORTION SHALL BE OMITTED AND THE ENTIRE AREA BETWEEN PLANTS SHALL BE MULCHED TO BLEND IN WITH THE CULTIVATED BED.
- PLANTING BEDS (CULTIVATED AND NON-CULTIVATED) SHALL BE CUT TO A MAXIMUM 4" IN HEIGHT BY MOWING, AND SHALL AFTERWARDS BE TREATED WITH HERBICIDE AS APPROVED AND DIRECTED BY THE ENGINEER AT LEAST 2 WEEKS PRIOR TO CULTIVATION, PLANTING, OR MULCHING.
- WHEN BARE ROOT PLANTS ARE USED IN BEDS, SHRUB AND ROOT PLACEMENT SHALL CONFORM TO DETAIL .
- SFM FOLLOWING BED DESIGNATION STANDS FOR SQUARE FEET OF MULCH AT THE INDICATED QUANTITY.

2 BARE ROOT PLANTS

L-5

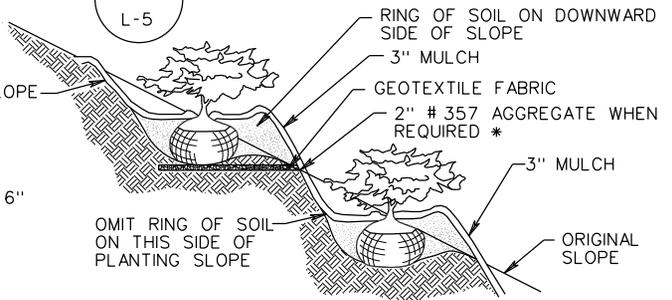

4 SLOPE PLANTING

L-5

- WHEN BARE ROOT PLANTS ARE USED ON SLOPE, SHRUB AND ROOT PLACEMENT SHALL CONFORM TO DETAIL .
- ON SLOPES STEEPER THAN 3:1, THE FRONT CENTER OF THE PIT SHALL BE MODIFIED WHEN REQUIRED * TO INCLUDE A "V" CUT THE FULL DEPTH OF THE PIT. THE PIT SHALL BE DUG 2" DEEPER THAN SHOWN ON THE SUMMARY SHEET AND BACKFILLED WITH 2" OF #357 AGGREGATE, DAYLIGHTED TO THE SLOPE FACE, AND COVERED WITH GEOTEXTILE FABRIC PRIOR TO BACKFILLING WITH SOIL MIXTURE.

* SEE NOTE FOR PIT DRAINAGE MODIFICATION FOR SLOPE PLANTING SHEET 1201.06.

GENERAL NOTES:

- SEE LANDSCAPE SUMMARY SHEET FOR PIT SIZES.
- ROOT BALL SHALL BE POSITIONED LEVEL WITH FINISHED GRADE. SOIL MIXTURE SHALL TAPER ONTO BUT NOT OVER TOP OF THE ROOT BALL. MULCH SHALL EXTEND AT THE PROPER DEPTH OVER THE ENTIRE ROOT BALL AND PLANTING PIT, AND SHALL BE HAND TAPERED TO THE BASE OF ALL TRUNKS AND STEMS AFTER SPREADING.
- THIS RULE SHALL GOVERN WITH THE FOLLOWING EXCEPTIONS:
 - SLOPE PLANTINGS - SEE SLOPE PLANTING DETAILS.
 - INCLUSION OF PIT DRAINAGE SYSTEM - POSITION TOP OF ROOT BALL THE SAME AS FINISHED GRADE.
 - TREE GRATE PLANTING - SEE TREE GRATE PLANTING DETAILS IN PLANS.

VDOT	
ROAD AND BRIDGE STANDARDS	
SHEET 1 OF 1	REVISION DATE
1201.04	

PLANTING DETAILS

VIRGINIA DEPARTMENT OF TRANSPORTATION

SPECIFICATION REFERENCE
605 245 203

STAKING, GUYING

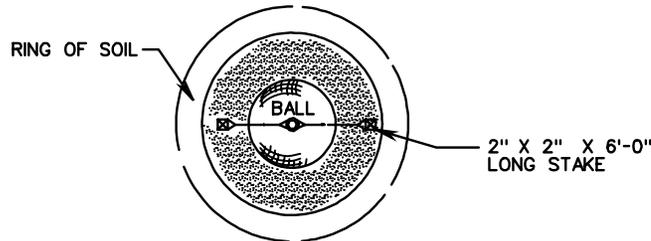
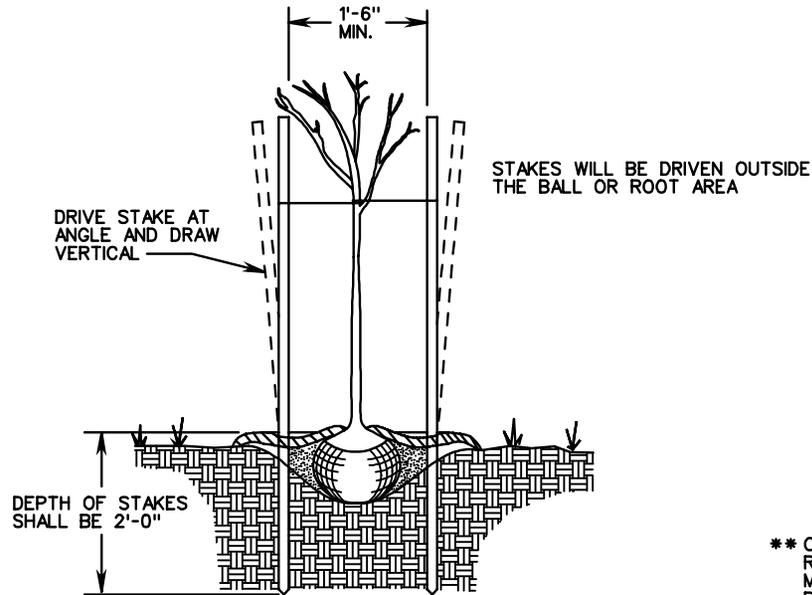

5
L-5 DOUBLE STAKING & STAKE PLACEMENT

DECIDUOUS TREES LESS THAN 2" IN CALIPER
EVERGREEN TREES LESS THAN 4 FEET IN HEIGHT
SHRUBS 4 FEET OR MORE IN HEIGHT.

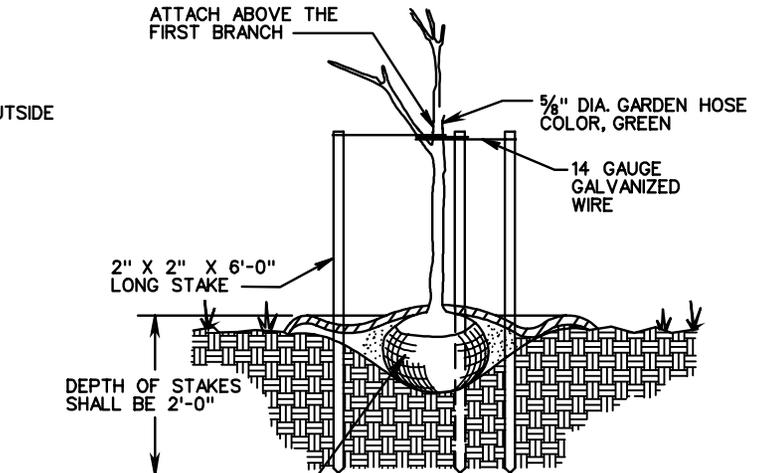

** CUT LOOSE AND DROP ROOT BALL WRAPPING MATERIALS TO THE BOTTOM OF THE PIT (TYPICAL)

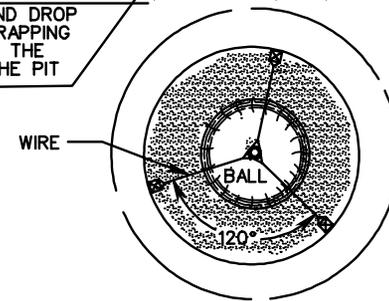

6
L-5 TRIPLE - GUYING

DECIDUOUS TREES 2" IN CALIPER OR GREATER
EVERGREEN TREES 4 FEET IN HEIGHT OR GREATER

GENERAL NOTES

1. ALL DECIDUOUS TREES OVER 4 FT. IN HEIGHT AND ALL EVERGREEN TREES OVER 4 FT. IN HEIGHT OR TALLER SHALL BE STAKED AND GUYED WITH 3 STAKES AS SHOWN.
2. MULTIPLE STEMMED DECIDUOUS TREES 4 FT. IN HEIGHT SHALL BE STAKED WITH 3 STAKES IN SUCH A MANNER AS TO STABILIZE 3 MAINSTEMS.
3. THE WOOD STAKES SHALL BE 2"X2"X6'-0" LONG DRESSED HARDWOOD AND DECAY RESISTANT.

THE WIRE TIES SHALL BE 14 GAUGE GALVANIZED WIRE, AND BE PROVIDED WITH A ONE FOOT PIECE OF GREEN RUBBER HOSE PLACED TO PREVENT INJURY TO THE BARK. THERE SHOULD BE A 1" - 3" SWAY IN THE TREE (THE WIRES SHOULD NOT BE PULLED TIGHT) FOR BEST ESTABLISHMENT. OTHER ANCHORING METHODS AND MATERIALS MAY BE APPROVED FOR USE BY THE ENGINEER.

** REMOVAL OF BINDING MATERIALS FROM TRUNKS AND STEMS, AND METAL CAGES FROM ROOT BALLS SHALL CONFORM TO THE CURRENT ROAD & BRIDGE SPECS.

SPECIFICATION REFERENCE
605 244

PLANTING DETAILS

VIRGINIA DEPARTMENT OF TRANSPORTATION



ROAD AND BRIDGE STANDARDS

REVISION DATE SHEET 1 OF 1

1201.05

L-5

PLANTING, STAKING, GUYING

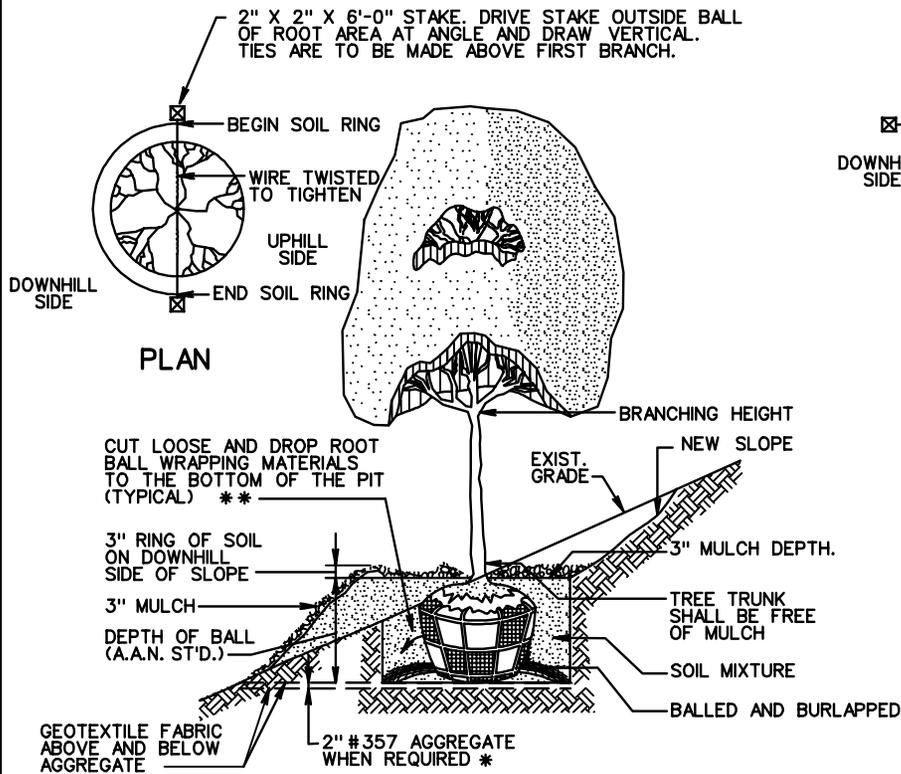

8 **DOUBLE STAKING & STAKE PLACEMENT**

DECIDUOUS TREES LESS THAN 2" IN CALIPER
EVERGREEN TREES LESS THAN 4' IN HEIGHT
AND SHRUBS 4' OR MORE IN HEIGHT

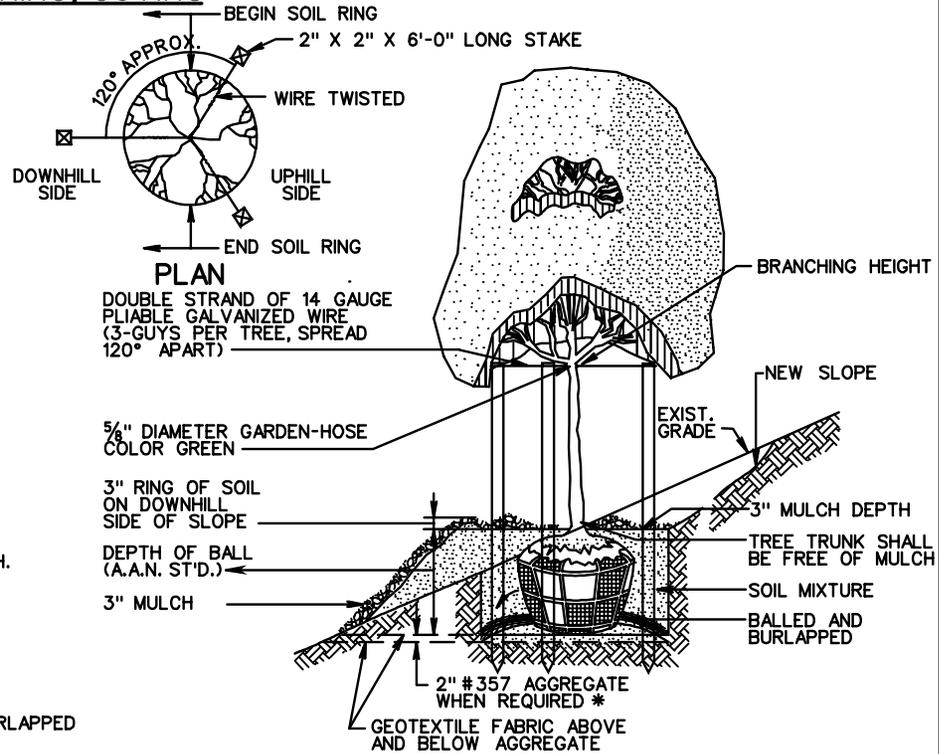

9 **TRIPLE GUYING**

DECIDUOUS TREES 2" IN CALIPER OR GREATER
EVERGREEN TREES 4' IN HEIGHT OR GREATER

GENERAL NOTES

1. ALL DECIDUOUS TREES 2" IN CALIPER OR MORE AND ALL EVERGREEN TREES OVER 4' IN HEIGHT SHALL BE STAKED OR GUYED AS SHOWN.
2. MULTIPLE STEMED DECIDUOUS TREES OVER 4' IN HEIGHT SHALL BE STAKED WITH 3 STAKES IN SUCH A MANNER AS TO STABILIZE 3 MAINSTEMS
3. THE WOOD STAKES SHALL BE CONSTRUCTION GRADE, ROUGH OR DRESSED, OF SOUND HARDWOOD, DECAY RESISTANT, AND OF THE SIZE INDICATED IN THE DETAILS.
4. THE WIRE TIES SHALL BE 14 GAUGE GALVANIZED WIRE OR OTHER APPROVED MATERIAL AND BE PROVIDED WITH A 1" PIECE OF GREEN RUBBER HOSE PLACED TO PREVENT INJURY TO THE BARK. THERE SHOULD BE A 1" - 3" SWAY IN THE TREE (THE WIRES SHOULD NOT BE PULLED TIGHT) FOR BEST ESTABLISHMENT. OTHER ANCHORING METHODS AND MATERIALS MAY BE APPROVED FOR USED BY THE ENGINEER.
5. ON SLOPES STEEPER THAN 3:1, THE FRONT CENTER OF THE PIT SHALL BE MODIFIED WHEN REQUIRED * TO INCLUDE A "V" CUT THE FULL DEPTH OF THE PIT. THE PIT SHALL BE DUG 2" DEEPER THAN SHOWN IN THE SUMMARY SHEET AND BACKFILLED WITH 2" OF #357 AGGRGATE DAYLIGHTED TO THE SLOPE FACE, AND COVERED WITH GEOTEXTILE FABRIC PRIOR TO BACK- FILLING WITH SOIL MIXTURE.

- * PIT DRAINAGE MODIFICATION FOR SLOPE PLANTING (WHEN REQUIRED)
 - ** REMOVAL OF BINDING MATERIALS FROM TRUNK AND STEMS, AND METAL CAGES FROM ROOT BALLS SHALL CONFORM TO SECTION 605.03 (I) OF THE SPECS.
- A. PRIOR TO THE PLANTING ON A SLOPE THE CONTRACTOR SHALL TEST NO MORE THAN 3 PITS FOR PERCOLATION.
 - B. PERCOLATION TEST SHALL CONSIST OF FILLING THE PIT WITH APPROXIMATELY 6" OF WATER. THE ENGINEER SHALL DETERMINE IF PIT DRAINAGE IS REQUIRED.
 - C. PAYMENT FOR AGGREGATE, GEOTEXTILE FABRIC, AND PIT MODIFICATION WILL BE MADE IN ACCORDANCE WITH THE ROAD AND BRIDGE SPECS.



ROAD AND BRIDGE STANDARDS

SHEET 1 OF 1

REVISION DATE

1201.06

SLOPE PLANTING DETAILS

VIRGINIA DEPARTMENT OF TRANSPORTATION

SPECIFICATION REFERENCE

203
245
605

FERTILIZER PLACEMENT

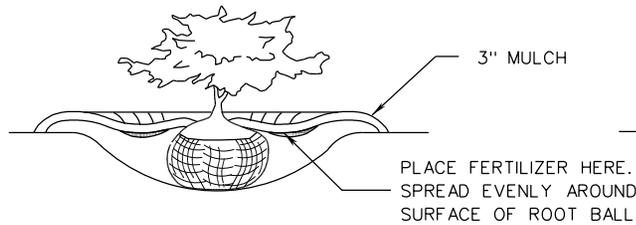

BALLED & BURLAPPED
& CONTAINER PLANTS

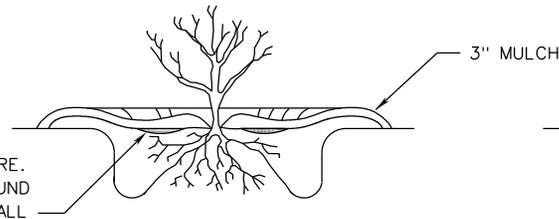

BARE ROOT PLANTS
WITHOUT TAPROOT

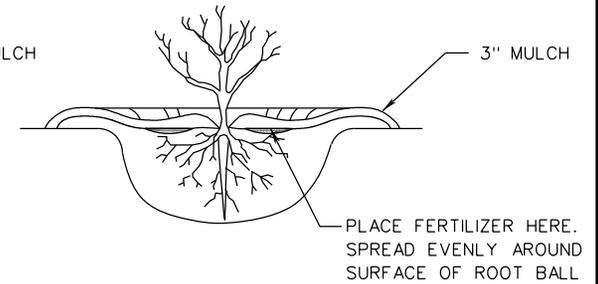

BARE ROOT PLANTS
WITH TAPROOT

FERTILIZER MATERIALS

FERTILIZER MATERIALS SHALL CONFORM TO THE SECTION 244 OF THE VDOT ROAD AND BRIDGE SPECIFICATIONS.

THE FOLLOWING INFORMATION SHALL BE SHOWN ON A TAG ATTACHED TO FERTILIZER BAG:

1. THE NAME AND ADDRESS OF MANUFACTURER
2. NAME OF MATERIAL
3. NUMBER OF NET POUNDS OF READY MIXED MATERIALS IN THE PACKAGE
4. CHEMICAL COMPOSITION AND ANALYSIS
5. GUARANTEED ANALYSIS (VA. DEPARTMENT OF AGRICULTURE)

MULCHING MATERIALS

BARK-SHALL BE DOUBLE SHREDDED HARDWOOD BARK, DISEASE FREE, BROWN IN COLOR AND SHALL CONFORM TO THE NATIONAL BARK AND SOIL PRODUCER ASSOC. STANDARDS FOR CLASSIFICATION, PARTICLE SIZE, PERCENTAGE WOOD CONTENT, MOISTURE RETENTION AND PH RATING. OTHER MULCH MATERIAL MAY BE USED WITH APPROVAL FROM THE ENGINEER.

FERTILIZER RATES

2 OUNCES PER VINE AND GROUND COVER UP TO ONE GALLON CONTAINER.

8 OUNCES PER SHRUB BARE ROOT OR ONE GALLON CONTAINER.

16 OUNCES PER SHRUB, BALLED AND BURLAPPED OR 2 THROUGH FIVE GALLON CONTAINER.

24 OUNCES PER TREE UNDER 2" CALIPER (INCLUDES MULTI-STEMMED AND EVERGREEN TREES UNDER 8")

32 OUNCES PER TREE OVER 2" CALIPER (INCLUDES MULTI-STEMMED AND EVERGREEN TREES OVER 8' IN HEIGHT)

THE FERTILIZER SHALL BE APPLIED AS A SURFACE APPLICATION. SPREAD EVENLY OVER TOP OF THE ROOT BALL AND PLANT PIT SOIL PRIOR TO MULCHING.

FERTILIZER SHALL NOT BE MIXED WITH THE SOIL MIXTURE.

APPROVED MULCHES

<u>TYPE</u>	<u>DEPTH</u>
DOUBLE SHREDDED HARDWOOD BARK	3"

SPECIFICATION REFERENCE 605 244	<h2>FERTILIZER AND MULCH</h2> <p>VIRGINIA DEPARTMENT OF TRANSPORTATION</p>	 ROAD AND BRIDGE STANDARDS REVISION DATE SHEET 1 OF 1 1201.07
--	--	--

TW-1

CRUSHED LIMESTONE SHALL NOT BE PLACED IN DIRECT CONTACT WITH THE ROOTS OF A TREE.

8" #78 AGGREGATE

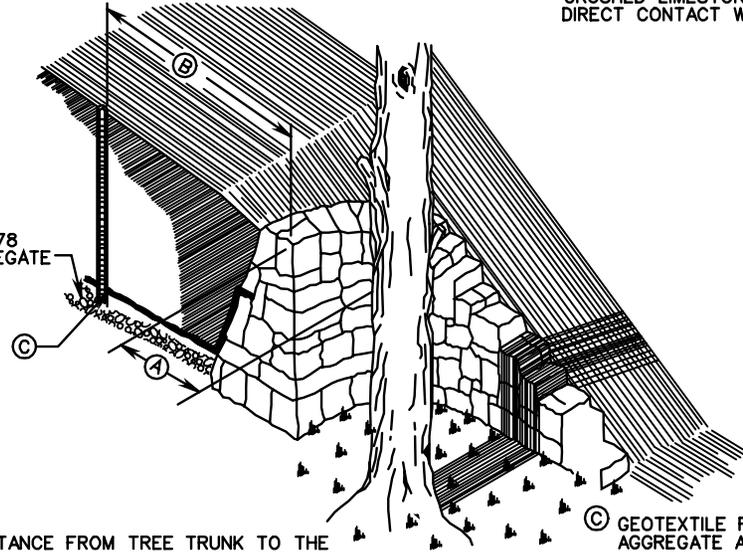

(A) DISTANCE FROM TREE TRUNK TO THE WALL OR WELL TO BE 1/4 OF THE SPREAD OF THE TREE, OR AS INDICATED ON THE PLANS.

(C) GEOTEXTILE FABRIC SHALL COVER ALL # 78 AGGREGATE AND 1/2 THE BACK SLOPE OF RETAINING WALL, AND SHALL BE LAID BETWEEN THE JOINTS ON DRY RUBBLE WALLS AT LEAST AT FIVE LOCATIONS AROUND THE WALL AS DETAILED.

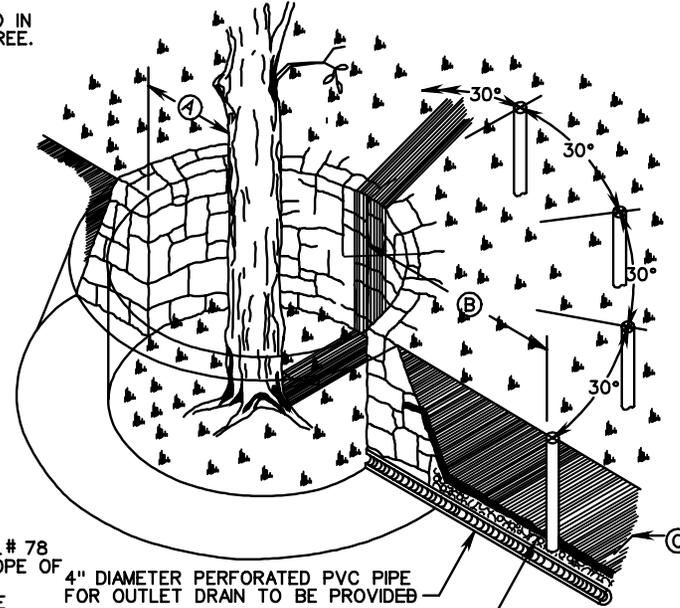

4" DIAMETER PERFORATED PVC PIPE FOR OUTLET DRAIN TO BE PROVIDED

8" #78 AGGREGATE

(B) 2" DIAMETER PVC PIPE PLACED AT DRIP LINE (30° DIAMETER O.C. AROUND TREE) AND REACHING TO #78 AGGREGATE.

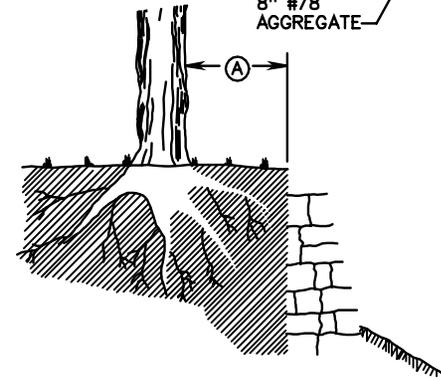
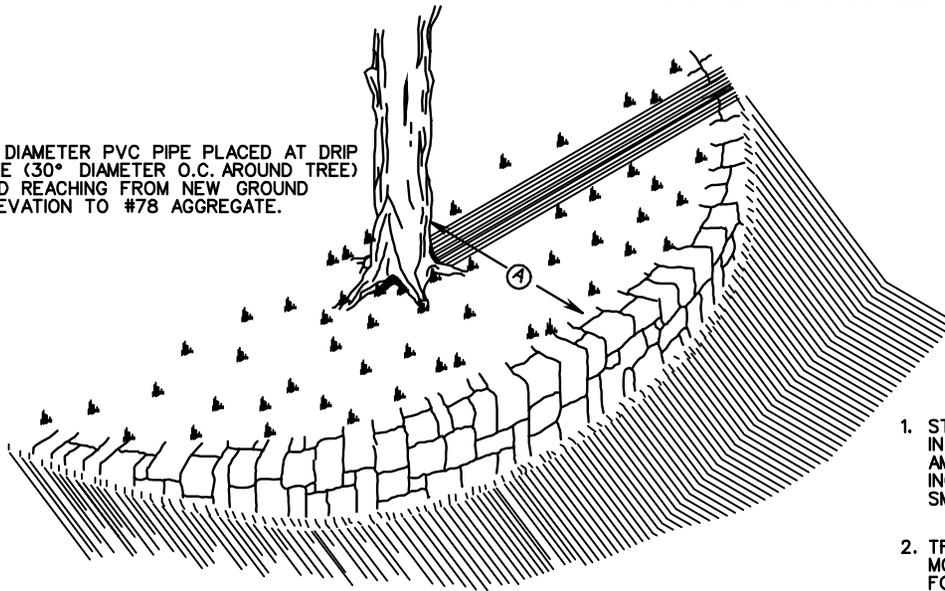

GENERAL NOTES

1. STANDARD TREE WALLS AND TREE WELLS SHALL BE MEASURED AND PAID FOR IN ACCORDANCE WITH SEC. 506 OF THE ROAD AND BRIDGE SPECS. AND AS AMENDED BY THE FOLLOWING: THE CONTRACT UNIT PRICE SHALL ALSO INCLUDE #78 AGGREGATE, 4" PERFORATED SMOOTH WALL PVC PIPE, 2" SMOOTH WALL PVC PIPE, AND GEOTEXTILE FABRIC COMPLETE IN PLACE.
2. TREE WALLS AND TREE WELLS ARE TO BE CONSTRUCTED OF DRY RUBBLE, MORTAR RUBBLE, BLOCK OR BLOCK FACED BRICK AS SHOWN IN THE PLANS. FOR DETAILS OF RETAINING WALL DESIGN AND FOUNDATION, SEE STANDARD RW-1, RW-1A, OR RW-1B UNLESS OTHERWISE NOTED ON PLANS.
3. ALL TREE WALL OR TREE WELL INSTALLATIONS ARE TO BE APPROVED BY THE ENGINEER.



ROAD AND BRIDGE STANDARDS

SHEET 1 OF 1

REVISION DATE

1201.08

STANDARD TREE WALLS AND TREE WELLS

SUGGESTED TREATMENT

VIRGINIA DEPARTMENT OF TRANSPORTATION

SPECIFICATION REFERENCE

203
232
245
506

RW-1

$\frac{E}{H}$	FOR UNLOADED WALLS	FOR LOADED WALLS
1.0	B - 0.50 H	B - 0.66 H
1.1	B - 0.57 H	B - 0.67 H
1.2	B - 0.61 H	B - 0.68 H
1.3	B - 0.64 H	B - 0.69 H
1.4	B - 0.66 H	B - 0.70 H
1.5	B - 0.67 H	B - 0.71 H
1.6	B - 0.69 H	B - 0.72 H
1.7	B - 0.70 H	B - 0.73 H
1.8	B - 0.71 H	B - 0.74 H
2.0	B - 0.73 H	B - 0.75 H
2.5	B - 0.75 H	B - 0.76 H
3.0	B - 0.77 H	B - 0.77 H

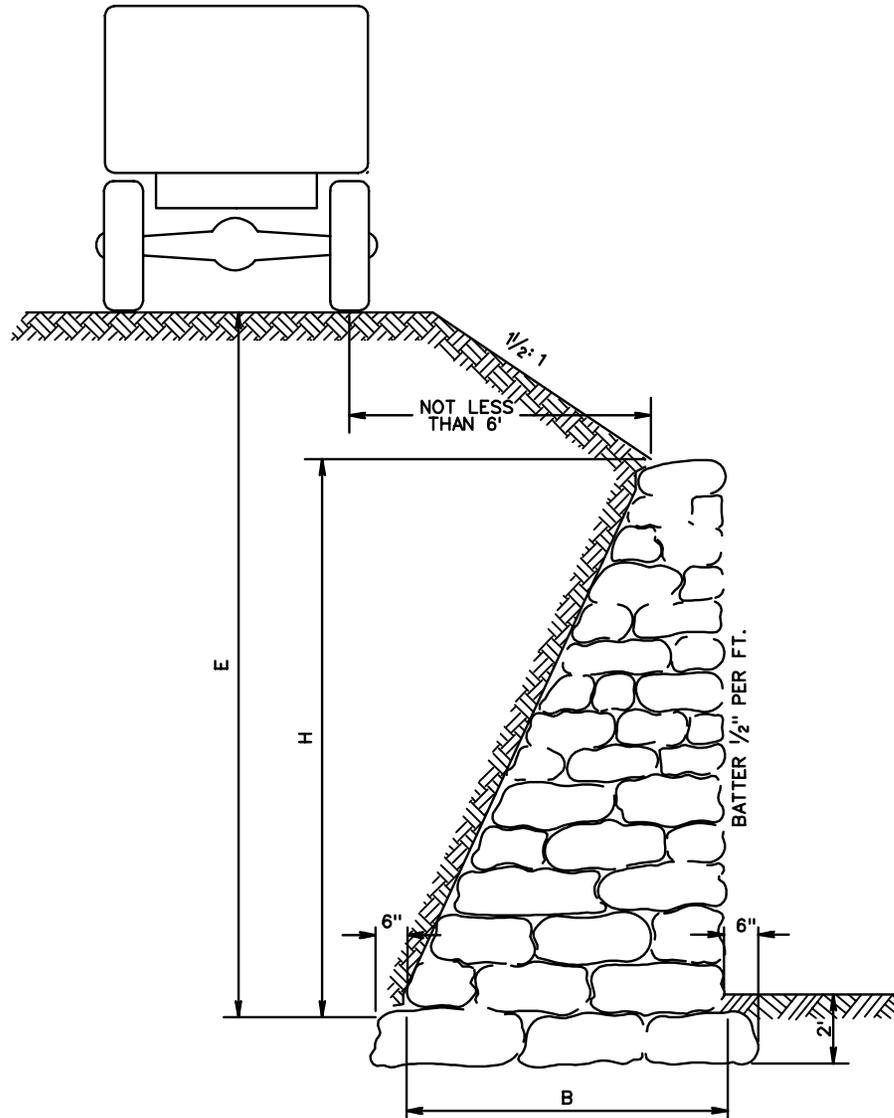

TOP THICKNESS FOR UNLOADED WALLS ARE TO BE 0.15 H WITH A MINIMUM THICKNESS OF 2 FT.

TOP THICKNESS FOR LOADED WALLS ARE TO BE 0.20 H WITH A MINIMUM THICKNESS OF 2.5 FT.

MINIMUM THICKNESS OF BASE = TOP THICKNESS

MAXIMUM HEIGHT OF WALL (H) IS TO BE 8 FT.



ROAD AND BRIDGE STANDARDS

DRY RUBBLE RETAINING WALLS

SPECIFICATION REFERENCE

SHEET 1 OF 1

REVISION DATE

506

1201.10

VIRGINIA DEPARTMENT OF TRANSPORTATION

HEIGHT OF WALL "H" IN FEET	THICKNESS AT TOP "A" IN FEET	THICKNESS AT BASE IN FEET	AREA OF WALL SQ. FEET	AREA OF FOOTING SQ. FEET
2	1'-6"	1'-6"	0.750	2.875
3	1'-6"	1'-6"	2.250	2.875
4	1'-6"	1'-7 $\frac{1}{4}$ "	3.828	2.997
5	1'-6"	2'-0"	5.862	3.513
6	1'-6"	2'-4 $\frac{3}{4}$ "	8.212	4.113
7	1'-6"	2'-9 $\frac{1}{2}$ "	12.060	4.615
8	1'-6"	3'-2 $\frac{1}{2}$ "	14.240	5.186
9	1'-6"	3'-7 $\frac{1}{4}$ "	17.813	5.762
10	1'-6"	4'-0"	21.781	6.344
11	1'-6"	4'-4 $\frac{3}{4}$ "	26.148	6.927
12	1'-6"	4'-9 $\frac{1}{2}$ "	30.909	7.516
13	1'-6"	5'-2 $\frac{1}{2}$ "	36.070	8.105
14	1'-6"	5'-7 $\frac{1}{4}$ "	41.629	8.696
15	1'-6"	6'-0"	47.587	9.288

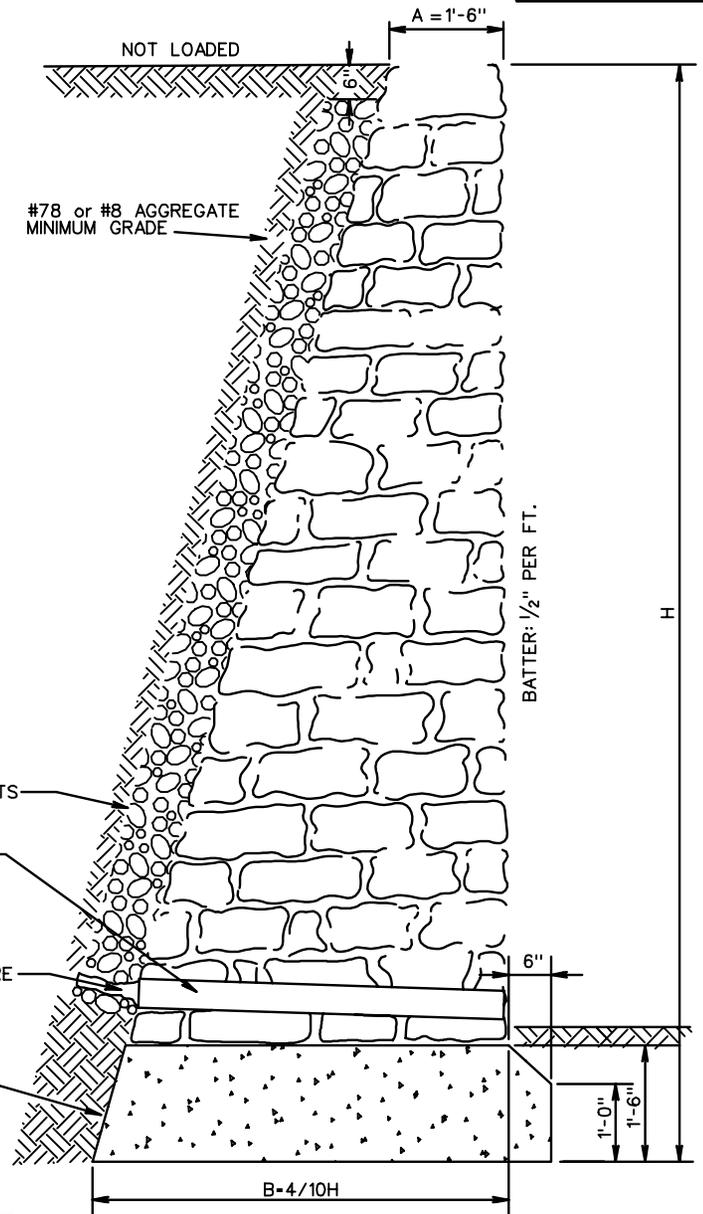

H = HEIGHT IN FEET
 A = 1'-6"
 BASE = 4/10 H
 EARTH = 100 Lbs.
 RUBBLE = 150 LBS.
 ANGLE OF REPOSE = 1 1/2 : 1

POROUS BACKFILL @ 100 LBS./CU. FT.
 #78 OR #8 AGGREGATE OR CRUSHED GLASS
 MEETING #78 OR #8 GRADATION REQUIREMENTS

3" DRAIN PIPES 8' C-C

WEEP HOLE WITH 12"x12" PLASTIC HARDWARE CLOTH
 1/4" MESH OR GALVANIZED STEEL WIRE, MINIMUM
 WIRE DIAMETER 0.03", NUMBER 4 MESH HARDWARE
 CLOTH ANCHORED FIRMLY TO OUTSIDE OF STRUCTURE

DRAIN PIPES ARE TO BE ONE CONTINUOUS LENGTH
 OR BELL AND SPIGOT WITH MORTARED JOINTS.

CLASS A3 OR C1 CONCRETE

NOTE:
 DEPTH OF WALL IN GROUND DETERMINED BY
 CONDITIONS. SHALL BE NOT LESS THAN 1'-6".
 IF COMPRESSION AT TOE EXCEEDS SAFE BEARING
 CAPACITY OF SOIL, A SPECIAL FOOTING IS TO BE USED.

SPECIFICATION REFERENCE
506

MORTAR RUBBLE RETAINING WALL
LEVEL BACKFILL
 VIRGINIA DEPARTMENT OF TRANSPORTATION

VDOT	
ROAD AND BRIDGE STANDARDS	
REVISION DATE	SHEET 1 OF 1
	1201.11

RW-1B

HEIGHT OF WALL "H" IN FEET	THICKNESS AT TOP "A" IN FEET	THICKNESS AT BASE IN FEET	AREA OF WALL SQ. FEET	AREA OF FOOTING SQ. FEET
3	1'-6"	1'-9 ⁵ / ₈ "	2.362	3.213
4	1'-6"	2'-4 ⁷ / ₈ "	4.453	3.972
5	1'-6"	3'-0"	7.087	4.788
6	1'-8"	3'-7 ¹ / ₄ "	10.763	5.663
7	1'-8"	4'-2 ³ / ₈ "	14.642	6.518
8	1'-9"	4'-9 ⁵ / ₈ "	19.429	7.396
9	1'-9"	5'-4 ⁷ / ₈ "	24.531	8.269
10	1'-10"	6'-0"	30.634	9.157
11	1'-10"	6'-7 ¹ / ₄ "	35.970	10.038
12	1'-11"	7'-2 ³ / ₈ "	44.395	10.930
13	1'-11"	7'-9 ⁵ / ₈ "	51.968	11.816
14	2'-0"	8'-4 ⁷ / ₈ "	60.714	12.711
15	2'-0"	9'-0"	69.530	13.595

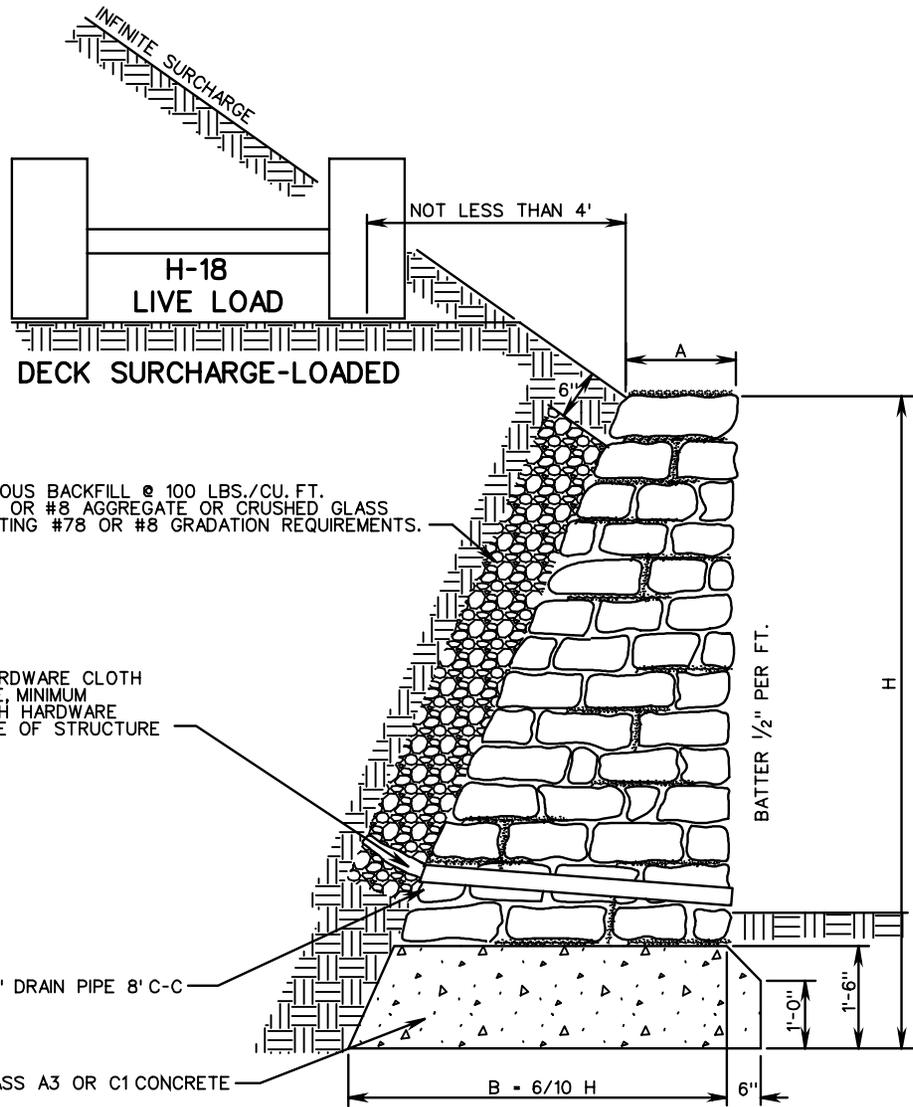

WEEP HOLE WITH 12"x12" PLASTIC HARDWARE CLOTH 1/4" MESH OR GALVANIZED STEEL WIRE, MINIMUM WIRE DIAMETER 0.03", NUMBER 4 MESH HARDWARE CLOTH ANCHORED FIRMLY TO OUTSIDE OF STRUCTURE

DRAIN PIPES ARE TO BE ONE CONTINUOUS LENGTH OR BELL AND SPIGOT WITH MORTARED JOINTS.

H = HEIGHT IN FEET

BASE = 6/10 H

WT. EARTH = 100 LBS./CU. FT.

WT. RUBBLE = 150 LBS./CU. FT.

ANGLE OF REPOSE = 1 1/2: 1

3" DRAIN PIPE 8' C-C

CLASS A3 OR C1 CONCRETE

NOTE:

IF COMPRESSION AT TOE EXCEEDS SAFE BEARING CAPACITY OF SOIL, A SPECIAL FOOTING IS TO BE USED.

DEPTH OF WALL IN GROUND SHALL BE DETERMINED BY CONDITIONS. SHALL BE NOT LESS THAN 1'-6".



ROAD AND BRIDGE STANDARDS

SHEET 1 OF 1

REVISION DATE

1201.12

MORTAR RETAINING WALL
INFINITE SURCHARGE AND DECK SURCHARGE - LOADED

VIRGINIA DEPARTMENT OF TRANSPORTATION

SPECIFICATION REFERENCE

506